

Motorised Curtain Pole System

Silent Gliss® 6150M Metropole 50mm

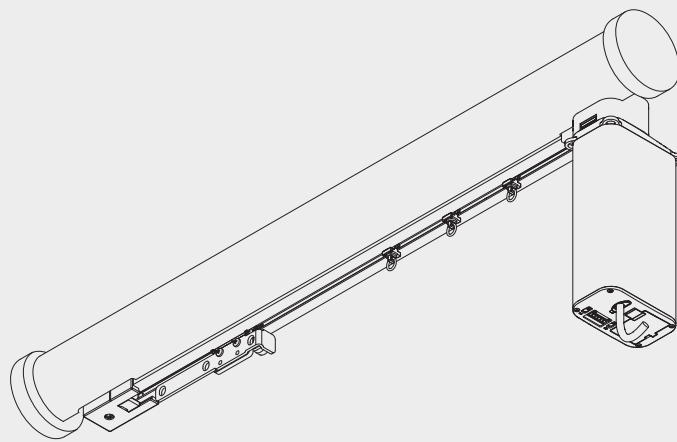

Product Information

- Electrically operated system for domestic and contract applications
- Choice of 9 different finishes - black, white, matt white, ecru, slate grey, antique bronze, taupe, anodic grey and silver
- Accessorised with matching end caps or finials
- Easy fitting to wall and ceiling
- Maximum curtain weight dependant on motorised system selection
- Suitable for use with Wave Standard curtain heading system
- Max pole length 5m/10m dependant on motorised system selection
- Available with 2 motor options with various operating methods



6150M

Profile Information

Metropole Fascia Profile

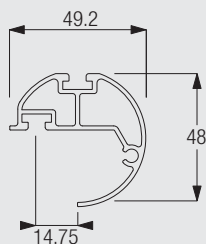

0360



Cannot be bent.

System 5600 Profile

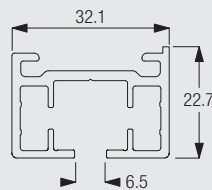

10850



Cannot be bent.

System 5100 Autoglide Profile

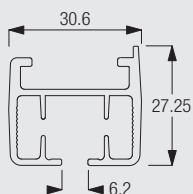

10925



Cannot be bent.

Specification Guide - download from www.silentgliss.co.uk (password required)

Silent Gliss 6150M curtain track, electrically operated, aluminium, assembled complete with gliders 6098/6143 and 2 endcovers 0350. Face fix with brackets 11206-208/11216-218/11209/0334/ top fix with bracket 6138P2/ 0335 each screwed to timber/plugged and screwed to block-work/concrete at 1000mm centres. Finished in black, white, matt white, ecru, slate grey, antique bronze, taupe, anodic grey or silver. Refer to table for motor colour see Motor Options in this catalogue.

How To Measure



Profile Cross Section

6150M

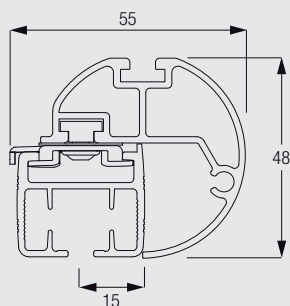

6150 with System 5100 Autoglide

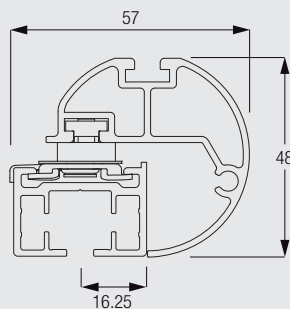

6150 with System 5600

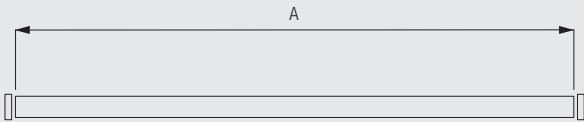

A: System Width - Important: please indicate when ordering whether your system width Includes (I) or Excludes (E) the finials.

Stack Size Calculation Wave Standard

Wave standard

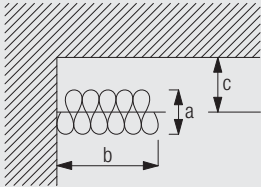

Glider-cord spacing	Curtain hook spacing	Approx. curtain fullness	Stack depth (a)	Stack width (b)	Min distance (c)
6	10	2.1	10	23 per metre of track + endpiece	8
6	12	2.3	12	23 per metre of track + endpiece	9
8	14	2.1	14	18 per metre of track + endpiece	10
8	16	2.3	16	18 per metre of track + endpiece	11

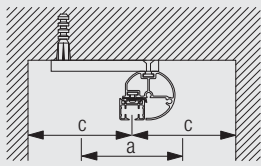

Wave standard with roller gliders

Glider-cord spacing	Curtain hook spacing	Approx. curtain fullness	Stack depth (a)	Stack width (b)	Min distance (c)
8	14	2.1	14	21 per metre of track + endpiece	10
8	16	2.3	16	21 per metre of track + endpiece	11

a = Stack depth
b = Stack size
c = Min. distance

(dimensions in cm)

Note: Minimum distance (c) includes a standard 3cm clearance (front and back).

All weight calculations are based on underslung curtains. Headings above the glider channel are not recommended.



6150M

System Dimensions

Maximum Curtain Weight Chart

	Application with Rollers		Application with Rollers and Wave Rollers				
	5100	3 m	5 m	5600	2 m	4 m	6 m
		20	25		25	45	45
		20	25		25	45	45

Note: Maximum recommended curtain weight for Wave curtain heading system is 2.5kg per metre unless using optional wave roller gliders

Design Options

Endcaps

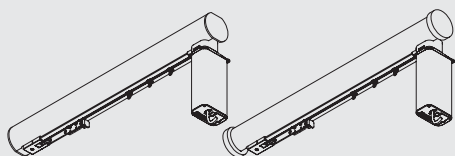

Without finials, poles are supplied as standard with flush fitting endcaps 0350 (left). Alternatively, stud endcaps 0714 (right) can be selected at no additional cost.

Finials

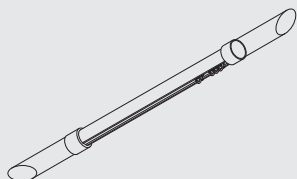

Finials are decorative elements that fit on at the end of the pole.

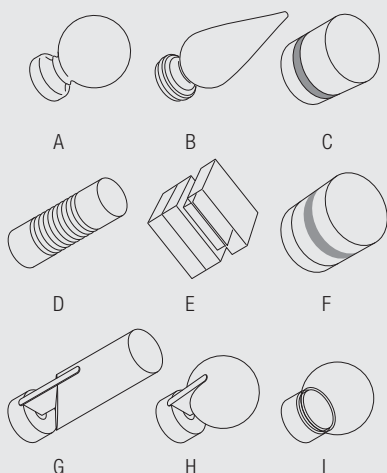

- A: 0717 Ball End 125mm
- B: 0718 Real Wood Spear 150mm
- C: 0697 Strata 65mm
- D: 0630 Groove Cylinder 125mm
- E: 0898 Crystal Cube 55mm
- F: 0899 Crystal Cylinder 55mm
- G: 0315 Fused Barrel 121mm (walnut/oak/matched)
- H: 0327 Fused Ball 81mm (walnut/oak/matched)
- I: 0333 Glass Ball (clear/frosted) 70mm



6150M

Wave Standard curtain heading system

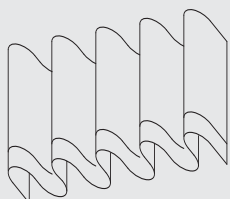

Wave is an exciting contemporary curtain heading system which allows curtains to hang in a continuous wave which is smooth, simple and elegant.

When using the Wave curtain heading system please note the maximum recommended curtain weight is 2.5kg/m. A greater weight may be achieved using wave roller glider 6098W (refer to System Dimensions).

Wave is available on System 6150 when using both System 5100 Autoglide and System 5600.

Wave parts - when using System 5100 Autoglide

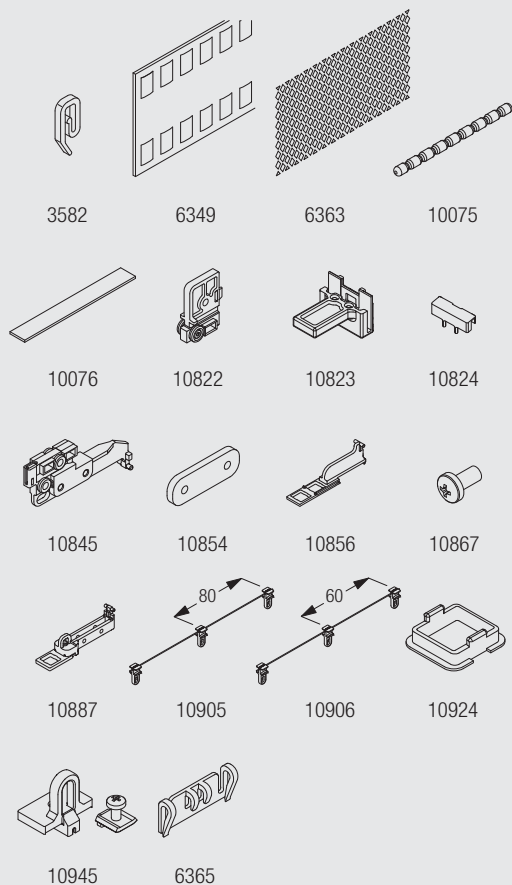

- 10822 Master carrier set
- 10823 Belt connector arm
- 10824 Belt connector pin
- 10845 Wave master carrier, single stack
- 10854 Wave overlap arm support
- 10856 Wave end stop, belt return
- 10867 Panhead screw
- 10887 Wave overlap arm set
- 10905 Wave glider cord (80mm)
- 10906 Wave glider cord (60mm)
- 10924 Wave glider support
- 10945 End stop

The following parts are supplied as standard when Silent Gliss curtains are supplied with the system. If only the track is supplied these are available at an extra cost:

- 6349 Curtain tape
- 3582 Hook
- 6363 Iron tape
- 10075 Lead weight 50gr/m
- 10076 Fabric weight

Notes:
Single stack 60mm Wave is not recommended.

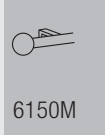

Wave - using System 5600

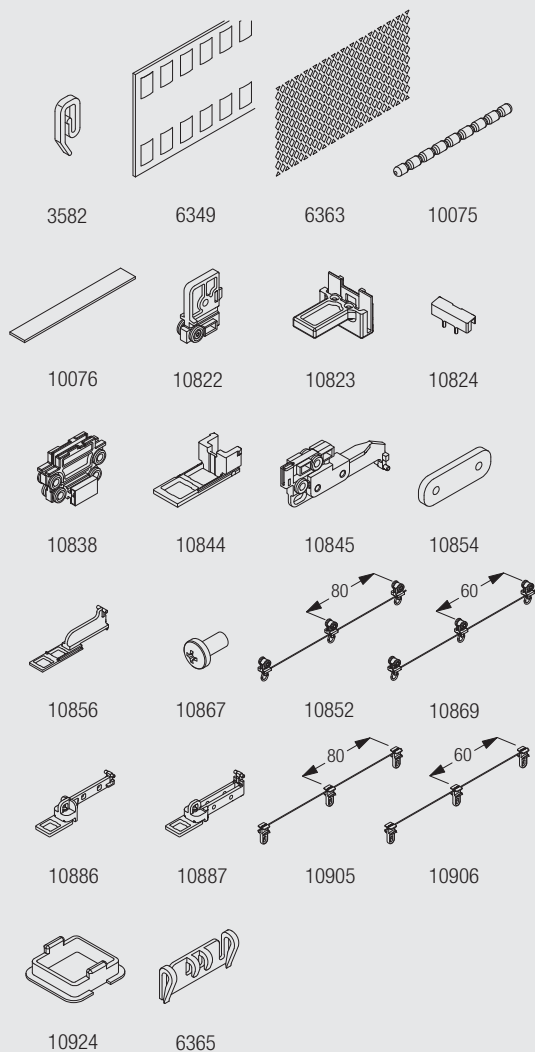

- 10822 Master carrier set
- 10823 Belt connector arm
- 10824 Belt connector pin
- 10838 Pilot runner set
- 10844 Motor end stop
- 10845 Wave master carrier, single stack 80mm
- 10852 Wave roller cord (80mm)
- 10854 Wave overlap arm support
- 10856 Wave end stop, belt return
- 10867 Panhead screw
- 10869 Wave roller cord (60mm)
- 10886 Wave overlap arm, pilot runner
- 10887 Wave overlap arm set
- 10905 Wave glider cord (80 mm)
- 10906 Wave glider cord (60 mm)
- 10924 Wave glider support

The following parts are supplied as standard when Silent Gliss curtains are supplied with the system. For hardware only orders these are available at extra cost:

- 10075 Lead weight 50gr/m
- 10076 Fabric weight
- 3582 Hook
- 6349 Curtain tape
- 6363 Iron tape

Note: Single stack 60mm Wave not recommended.

6150M

Fitting Information

Bracket Positioning

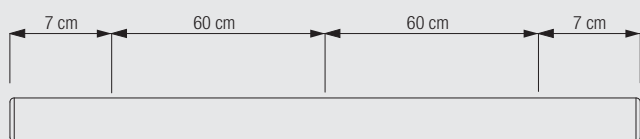

Fitting of track to bracket

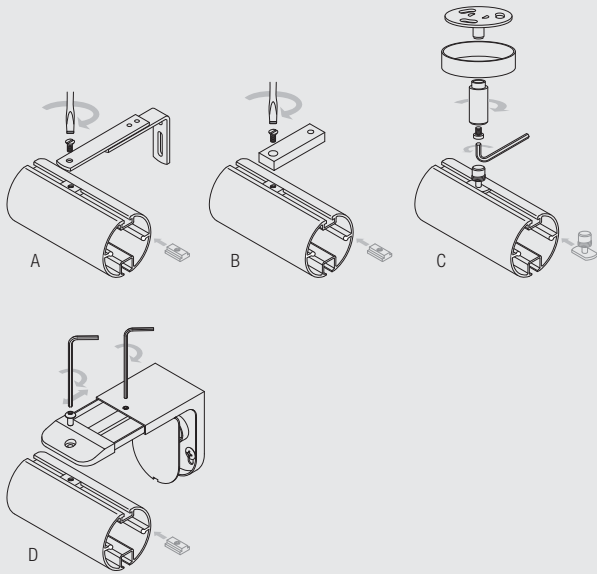

- A: Using adjustable bracket 11209
- B: Using ceiling fix bracket 6138p
- C: Using top fix bracket 0335
- D: Using maxi adjustable bracket 0334

All 50mm Metropole are supplied with Maxi bracket 0334 as standard unless otherwise specified.

Fitting Options

Wall fix with adjustable Smart Fix brackets 11209

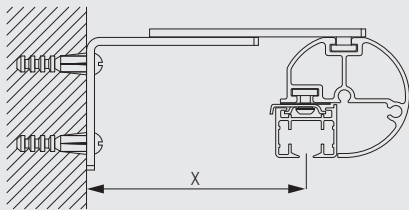

	X(mm)
11209	80-100

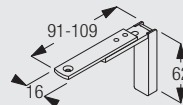

11209
Smart Fix with
extension arm set

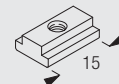

6141
Track insert (uses
screw 0798)

Brackets are threaded with M4x8

Ceiling fix with bracket 6138p2

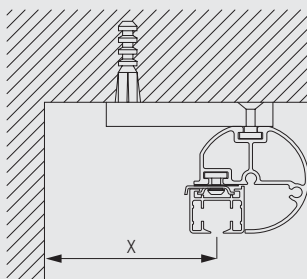

	X (mm)
6138P2	80

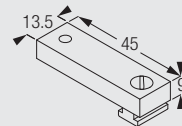

6138P2
Ceiling support set
(9mm)

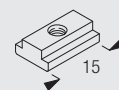

6141
Track insert (uses
screw 0798)

The distance 'x' will depend on the curtain style and any other obstacles.



6150M

Ceiling fix using top fix bracket 0335

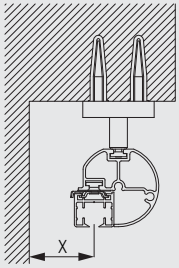

	X (mm)
0335	50

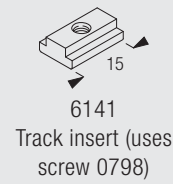
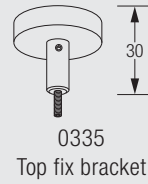

The distance 'x' will depend on the curtain style and any other obstacles.

Wall fix with maxi adjustable bracket 0334

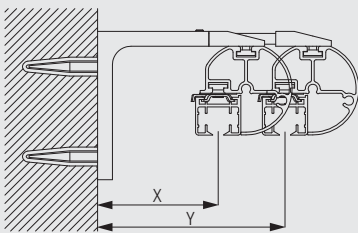

	X (mm)	Y (mm)
0334	80	100

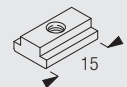
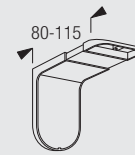

0334
Maxi adjustable
bracket

6141
Track insert (uses
screw 0798)

Wall fitting with Smart Fix with slot 11206-08

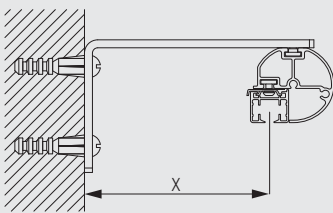

	X (mm)
11206	33-51
11207	53-71
11208	73-91

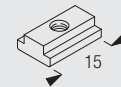

6141
Track insert (uses
screw 0798)



6150M

Brackets are threaded with M4x8

Wall Fitting with Square Smart Fix with slot 11216-11218

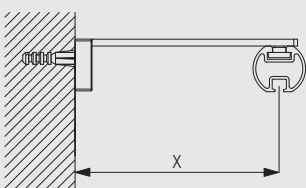

	X (mm)
11216	33-51
11217	53-71
11218	73-91

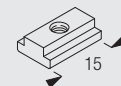
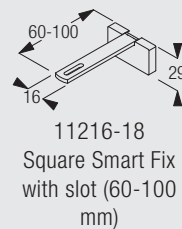

6141
Track insert (uses
screw 0798)

Brackets are threaded with M4x8

Standard Accessories

Parts

0334 Maxi adjustable bracket



0350 Flush endcap (50mm)



0360	Profile		3004	Clamp	
6086	Spring stop		10840	Two component roller	
10850	Profile		10925	Profile	
10926	Clamp		10931	Roller	

Optional Accessories





Parts

0315	Fused barrel (50mm)		0327	Fused ball (50mm)	
0333	Glass ball (50mm)		0335	Top fix bracket	
0630	Groove Cylinder (50mm)		0697	Strata (50mm)	
0714	Stud End cap (50mm)		0717	Ball end finial (50mm pole)	
0718	Spear finial (50mm pole)		0898	Crystal Square (50mm)	
0899	Crystal Cylinder (50mm)		6007	Endstop	
6283	Roller glider		10926	Clamp	
11206	Smart Fix, 60 mm with slot set		11207	Smart Fix, 80 mm with slot set	
11207	Smart Fix, 80 mm with slot set		11209	Smart Fix with extension arm set	
11216	Square Smart Fix, 60 mm with slot set		11217	Square Smart Fix, 80 mm with slot set	
11218	Square Smart Fix, 100 mm with slot set		6138P2	Ceiling support set (9mm)	

6150M

Wave Accessories

The Wave parts listed below may apply to one or both Systems 5100 and 5600. Some parts are used on both, some are used on one or other of the systems.

3582	Hook		6007	Endstop	
6349	Wave curtain heading tape		6363	Top hemming tape	
10075	Lead weight 50 gr/m		10076	Fabric weight	
10822	Master carrier set		10823	Belt connector arm	
10824	Belt connector pin		10838	Pilot runner set	
10844	Wave end stop, motor		10845	Wave master carrier, single stack 80mm	
10852	Wave roller cord (80mm), 6.5mm channel		10854	Wave overlap support arm	
10856	Wave end stop, belt return		10867	Panhead screw M4x16	
10869	Wave roller cord (60mm), 6.5mm channel		10886	Wave overlap arm, pilot runner set	
10887	Wave overlap arm set		10905	Wave glider cord (80mm), 6.5mm channel	
10906	Wave glider cord (60mm), 6.5mm channel		10924	Wave glider support	



Motor Options

Motor Colours

The motors are hidden behind the curtain, however, visible motor parts (the small top section), is colour matched to the profile.

Option 1: System 5100 Autoglide with motor 5190

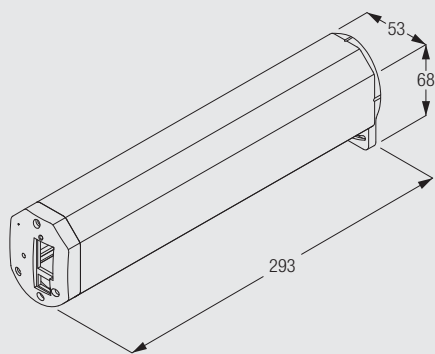

- Torque: 1.0Nm
- Speed: 130rpm
- Speed: 15cm/S
- Voltage: 100 - 240 V AC 50/60 Hz
- Power: 72W
- Safety class: IP20
- Noise level: < 45 dBA (30cm)
- Thermal overload protection
- Temperature for operation: 0°C to + 60°C
- Frequency receiver of Motor: 433.92 MHz

The motor 5190 is supplied with a 5m power cable with a 3 pin plug.

Option 2: System 5600 using Motor 9060 (100-250V AC & 24V DC)

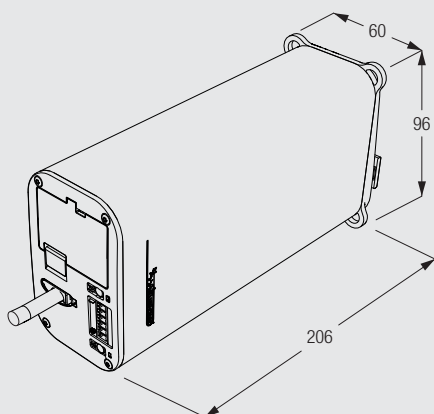

- Voltage: 100-250V AC
- Frequency: 50-60Hz
- Current: 1.3/0.45A
- Speed: 160/120rpm
- Noise level: <36 dBA
- Thermal overload protection
- ETL/UL, CE/IECEE Standard
- Weight: 1.4kg

Important: For Radio Control system 0450 order module 9063, Radio Control system 9940 order module 9063EL.

For further information on the above electric track systems please refer to the Electric Curtain Track Systems catalogue (www.silentgliss.co.uk).



6150M