

SG 7640

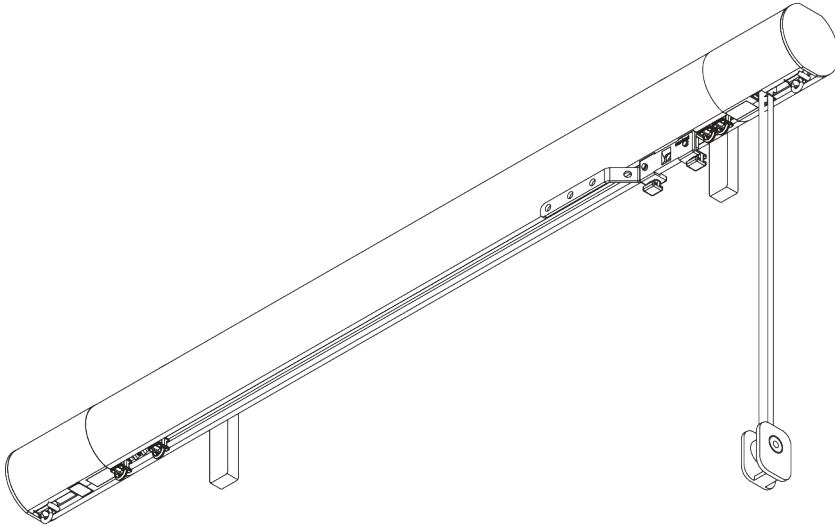
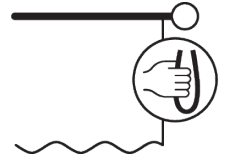

PRODUCT INFORMATION

- **Operation:** cord
- **Range:** M - L
- **Fitting:** ceiling, wall
- **Colours:** white RAL 9016, various colours / finishes
- **Fabrics:** refer to Silent Gliss fabric collection

Features:

- 2-component (2C) glider technology
- Wave (2C)
- Matching endcaps and brackets / bracket covers
- Range of decorative finials
- Bendable

SYSTEM SPECIFICATIONS

A. SYSTEM DIMENSIONS



6 m

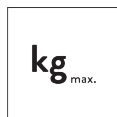

13 kg

Max. curtain weights

	Standard Application with Glider						Standard Application with Roller/ Wave Roller					
	1 m	2 m	3 m	4 m	5 m	6 m	1 m	2 m	3 m	4 m	5 m	6 m
	9	9	8	8	7	7	12	11	11	11	10	10
	10	10	9	9	8	8	13	13	12	11	11	10
	7	7	6	6	5	5	9	8	8	8	7	7
	8	8	7	7	6	6	10	9	9	9	8	8
	4	4	3	3	2	2	6	5	5	5	4	4
	5	5	4	4	3	3	7	6	6	6	5	5
	3	3	2	2	1	1	5	4	4	4	3	3
	4	4	3	3	2	2	6	5	5	5	4	4

(kg max.)

B. PROFILE

Profile and bending information

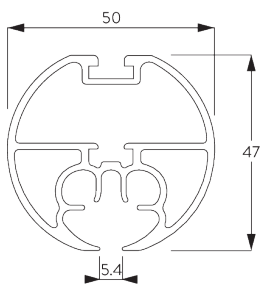

SG 11607

Profile

Radius:
✓ >68 cm

**C. HOW TO
MEASURE**

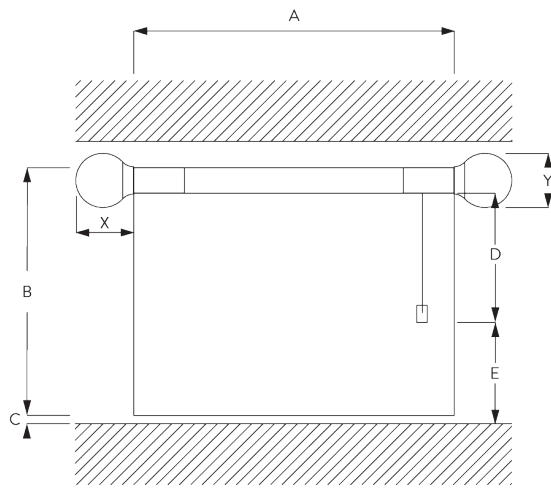

- A: System width without finials
- B: System height
- C: Distance between floor and fabric
- D: Cord height
- E: Safety Retainer SG 10731 min. 150 cm above floor
- X: Finial width
- Y: Finial height

Finial Measurements

		50 mm	
		X	Y
	SG 11605	2	51
	SG 11651	10	56
	SG 11652	24	75
	SG 11753	115	51
	SG 11754	83	70
	SG 11756	90	85
	SG 11757	165	70
	SG 11758	32	130
	SG 11759	30	100

D. SPECIFICATION

TEXT

Silent Gliss SG 7640 'Metropole' cord operated curtain track system. Comprises 50 mm aluminium profile SG 11607 supplied made to measure with 2C gliders SG 11300 at 14/m, 2 no. flush end covers SG 11605, cording set SG 20347, overlap SG 6063 and cord SG 3091. Supplied as standard with wall 'face' fix Maxi brackets SG 20334 at max. 600 mm centres. Optional wall fix brackets SG 11206-11208 / SG 11216-11218 / SG 11209 / SG 11472 / Fillet bracket SG 11669. Bent systems for wall 'face' fix supplied as standard with adjustable Smart Fix bracket SG 11209. Ceiling 'top' fix with plate SG 6151 / bracket SG 6175 / SG 11668 at max. 600 mm centres. Finished in Black, White, Matt White, Ecru, Slate Grey, Bronze, Antique Bronze, Anodic Grey and Taupe. A range of decorative finials are available. Silent Gliss Wave option is available using 60 mm glider cord SG 11303 / 80mm glider cord SG 11302 / 80 mm roller glider cord SG 6099. Compliant to Child Safety legislation EN 13120.

FITTING

A. FITTING INFORMATION

For detailed fitting information, visit the [Silent Gliss website](#).

Fixing points

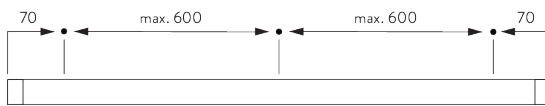

B. CEILING FITTING

Support SG 6152

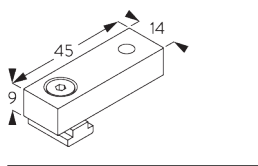
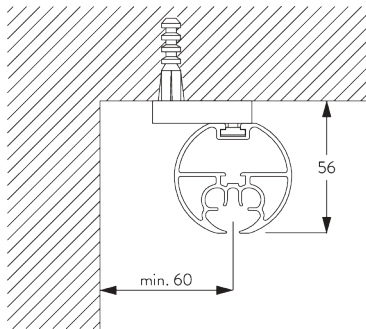

SG 6152

Ceiling support set 9 mm

Top fix bracket SG 11668

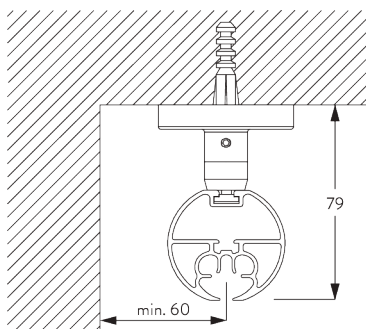

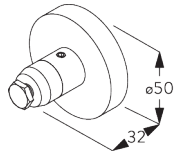

SG 11668

Top fix bracket

Mini hanger SG 6175

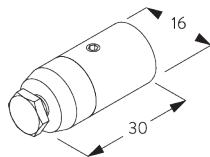
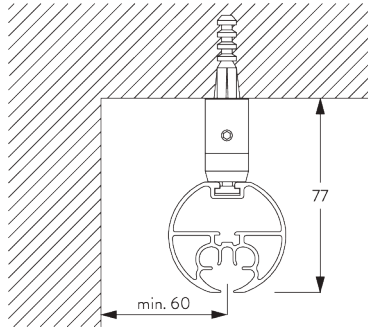

SG 6175

Mini hanger

C. WALL FITTING

Smart Fix

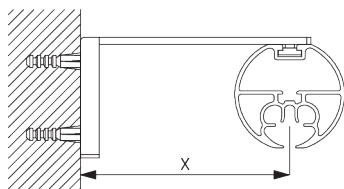

Smart Fix with slot SG 11206 - SG 11208 and SG 6141:
Screw SG 6783 (M4x10) needed.

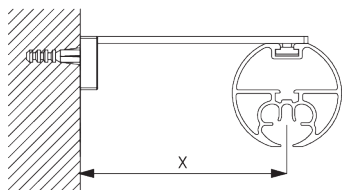

Square Smart Fix with slot SG 11216 - SG 11218 and SG 6141:
Screw SG 6783 (M4x10) needed.

Smart Fix	X mm
SG 11206 / SG 11216	51
SG 11207 / SG 11217	71
SG 11208 / SG 11218	91
SG 11209 / SG 11472	80-100

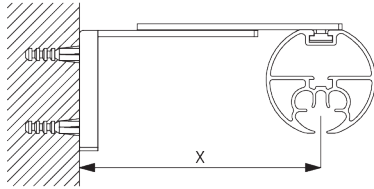

Adjustable Smart Fix SG 11209 and SG 6141:
Screw SG 6784 (M4x8) needed.

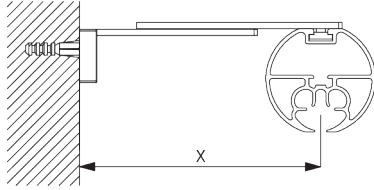

Adjustable Square Smart Fix SG 11472 and SG 6141:
Screw SG 6784 (M4x8) needed.

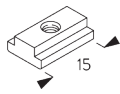

SG 6141
Clamping piece



SG 6783
Hexagon socket countersunk screw M4x10 mm



SG 6784
Hexagon socket countersunk screw M4x8 mm

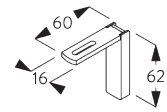

SG 11206
Smart Fix with slot 60 mm

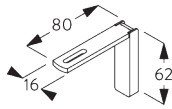

SG 11207
Smart Fix with slot 80 mm

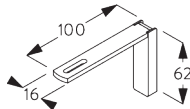

SG 11208
Smart Fix with slot 100 mm

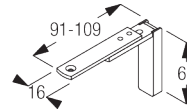

SG 11209
Adjustable Smart Fix

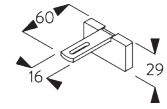

SG 11216
Square Smart Fix with slot 60 mm

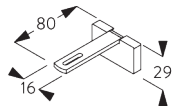

SG 11217
Square Smart Fix with slot 80 mm

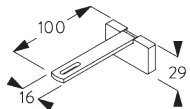

SG 11218
Square Smart Fix with slot 100 mm

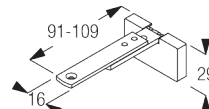

SG 11472
Adjustable Square Smart Fix

**Fillet Bracket
SG 11669**

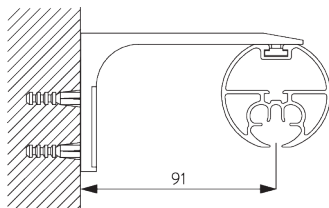

Screw SG 6784 (M4x8) needed.
Recommended for straight systems only.

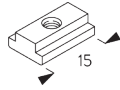

SG 6141

Clamping piece



SG 6784

Hexagon socket countersunk
screw M4x8 mm

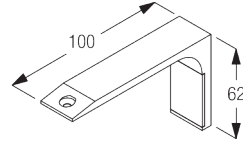

SG 11669

Fillet bracket

Maxi adjustable bracket SG 20334

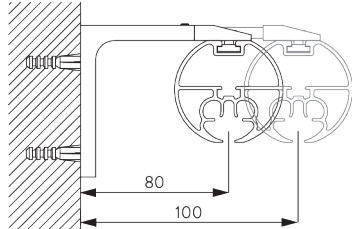

Screw SG 6783 (M4x10) needed.

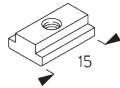

SG 6141

Clamping piece



SG 6783

Hexagon socket countersunk
screw M4x10 mm

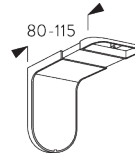

SG 20334

Maxi adjustable bracket

DESIGN & SYSTEM OPTIONS

A. ENDCAPS



SG 11605



SG 11651



SG 11652

Endcaps:

- SG 11605 Flush endcap 50 mm
- SG 11651 Stud endcap 50 mm
- SG 11652 Design endcap 50 mm

Please note:

- Without finials, poles are supplied as standard with flush fitting endcaps SG 11605 (left).
- Alternatively, stud endcaps SG 11651 can be selected at no additional cost.

B. FINIALS

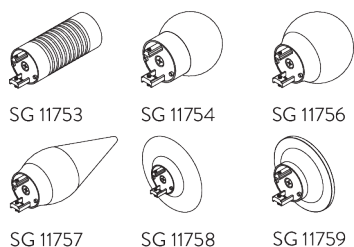

Finials are decorative elements that fit on at the end of the pole:

- SG 11753 Groove cylinder 50 mm
- SG 11754 Glass ball 50 mm
- SG 11756 Ball end 50 mm
- SG 11757 Spear 50 mm
- SG 11758 Ellipse 50 mm
- SG 11759 Taper 50 mm

C. WAVE

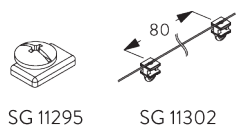
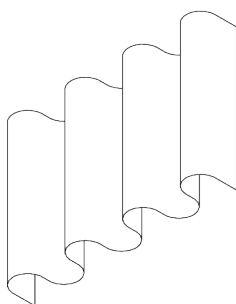

Standard components:

- SG 11295 End stop
- SG 11302 Wave 2C glider cord 80 mm

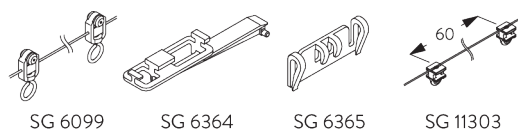

Optional component:

- SG 6099 Wave roller cord 80 mm
- SG 6364 Wave extension
- SG 6365 Wave hanger
- SG 11303 Wave 2C glider Cord 60 mm

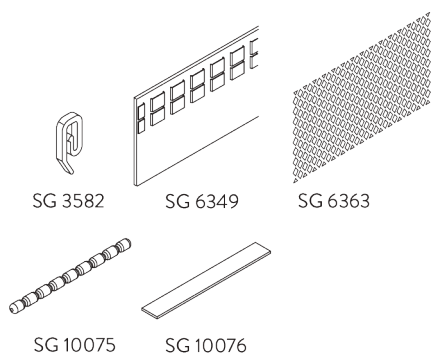

Curtain components:

- SG 3582 Hook
- SG 6349 Wave curtain tape
- SG 6363 Wave top hemming tape
- SG 10075 Lead weight 50 gr/m
- SG 10076 Fabric weigh

Wave stack depth - 2C glider cord (standard components)

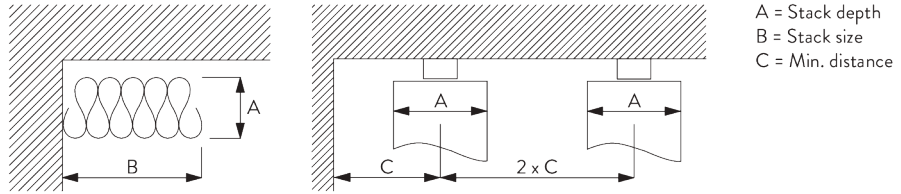

2C Glider cord SG 11302	Pockets between hooks	Approx. curtain fullness	Stack depth A	Stack size B*	Min distance C
80	6	~2.1	140	180 per metre of track	90
80	7	~2.3	160	180 per metre of track	100

2C Glider cord SG 11303	Pockets between hooks	Approx. curtain fullness	Stack depth A	Stack size B*	Min distance C
60	4	~2.1	100	230 per metre of track	70
60	5	~2.3	120	230 per metre of track	80







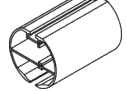
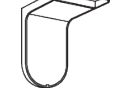



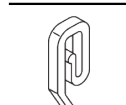
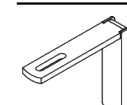
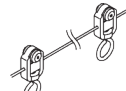
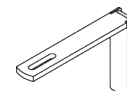
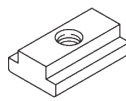
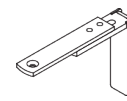
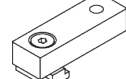
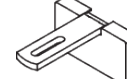
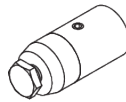
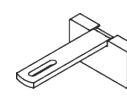

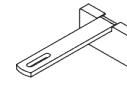
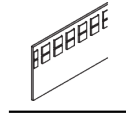
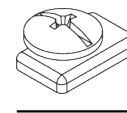
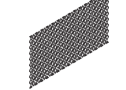
*Stack size B when using optional extension arm SG 6364 increases by 175 mm per curtain stack!

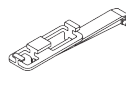
PARTS

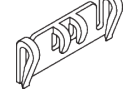
A. STANDARD PARTS

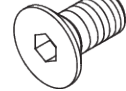
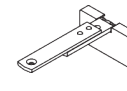
	SG 3091 Cord ø 3.5 mm
	SG 6063 Overlap arm
	SG 6065 End stop
	SG 6173 Connection bridge
	SG 6354 Pilot runner
	SG 6783 Hexagon socket countersunk screw M4x10 mm
	SG 10731 Child safety retainer set
	SG 11300 2C glider
	SG 11605 Flush end cap 50 mm
	SG 11607 Profile
	SG 11662 Cord guide 50 mm
	SG 11703 Cover
	SG 11704 Cover
	SG 20334 Maxi adjustable bracket

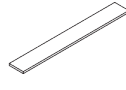
B. OPTIONAL PARTS

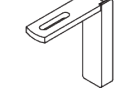
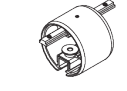
	SG 3582 Hook		SG 11207 Smart Fix with slot 80 mm
	SG 6099 Wave roller cord 80 mm		SG 11208 Smart Fix with slot 100 mm
	SG 6141 Clamping piece		SG 11209 Adjustable Smart Fix
	SG 6152 Ceiling support set 9 mm		SG 11216 Square Smart Fix with slot 60 mm
	SG 6175 Mini hanger		SG 11217 Square Smart Fix with slot 80 mm
	SG 6283 Roller		SG 11218 Square Smart Fix with slot 100 mm
	SG 6349 Wave curtain tape		SG 11295 End stop
	SG 6363 Wave top hemming tape		SG 11301 2C glider on strip
	SG 6364 Wave extension		SG 11302 Wave 2C glider cord 80 mm
	SG 6365 Wave hanger		SG 11303 Wave 2C glider cord 60 mm
	SG 6784 Hexagon socket countersunk screw M4x8 mm		SG 11472 Adjustable Square Smart Fix
	SG 10075 Lead weight 50 g/m		SG 11651 Stud endcap 50 mm
	SG 10076 Fabric weight		SG 11652 Design endcap 50 mm
	SG 11206 Smart Fix with slot 60 mm		SG 11664 Intermediate guide 50 mm



SG 11668
Top fix bracket

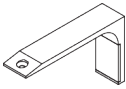

SG 11669
Fillet bracket

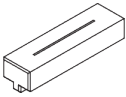

SG 11702
Connection bridge

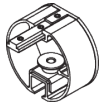

SG 11717
Wave single stack return pulley 50 mm

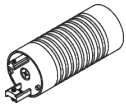

SG 11753
Groove cylinder 50 mm

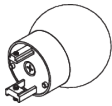

SG 11754
Glass ball 50 mm

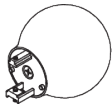

SG 11756
Ball end 50 mm

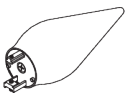

SG 11757
Spear 50 mm



SG 11758
Ellipse 50 mm



SG 11759
Taper 50 mm

